

300M	m	1.88	2.5	4.48	6.37	8.31	10.22	12.14
	kg	15000	12000	6150	4180	3150	2580	2200

BS 300M	
Lifting Capacity(KN.m)	300
Standard Reach(m)	12.14
Rotation	385°
Working Pressure(MPa)	30
Pump Capacity(cc/r)	40-100
Oil Tank Capacity (L)	160
Crane Weight (kg)	4080±50

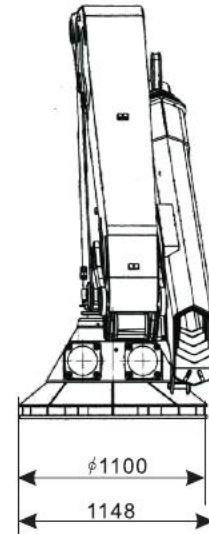

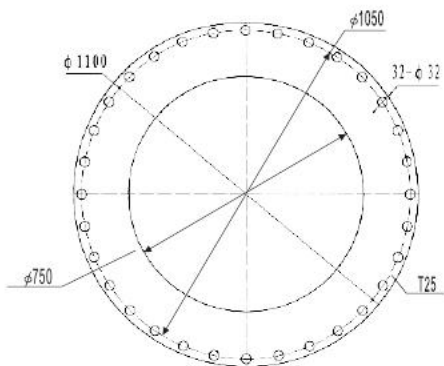
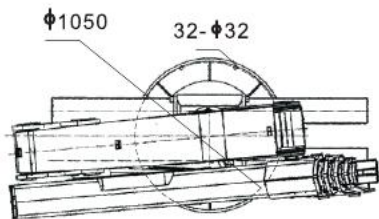

Mounting Plate

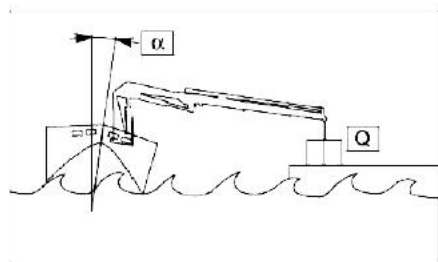
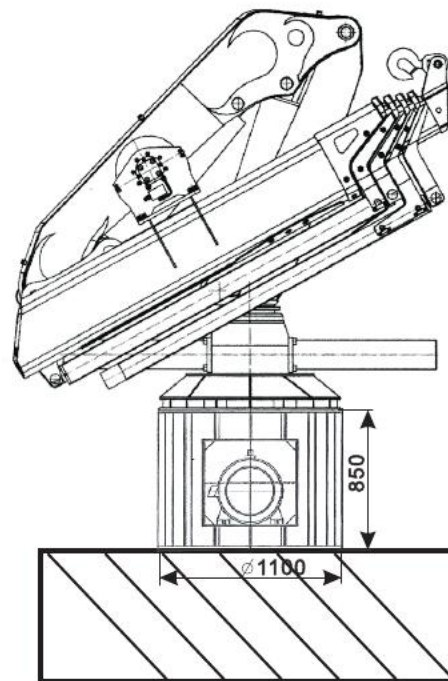

Power Station Parameter

Oil tank capacity (L)	300L
Power (KW)	18.5kw
Pump capacity (cc/r)	Below 60cc

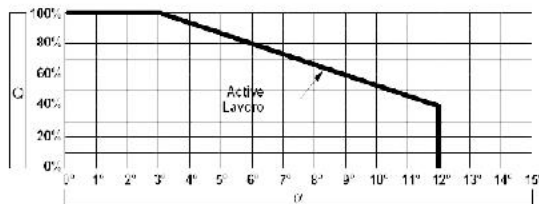
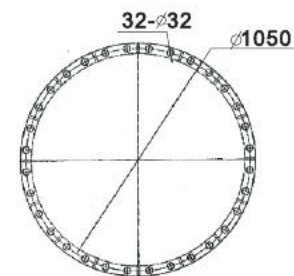

Options:

1. Power Station
2. Rod plating: Hard Cr or WC or Ceramic(Cr203)
3. Fitting & Coupling: Stainless Steel or Zn plated
4. Winch